



## SEMIPACK® 4

### Rectifier Diode Modules

#### SKKE 600

#### Features

- Heat transfer through aluminium nitride ceramic isolated metal baseplate
- Precise metal pressure contacts for high reliability
- UL recognized, file no. E 63 532

#### Typical Applications\*

- Rectifiers

$V_{RSM}$ V	$V_{RRM}$ V	$I_{FRMS} = 930$ A (maximum value for continuous operation) $I_{FAV} = 600$ A (sin. 180; $T_c = 100$ °C)	
1200	1200	SKKE 600/12	
1600	1600	SKKE 600/16	
2000	2000	SKKE 600/20H4	
2200	2200	SKKE 600/22H4	

Symbol	Conditions	Values	Units
$I_{FAV}$	sin. 180; $T_c = 100$ °C	600	A
$I_{FSM}$	$T_{vj} = 25$ °C; 10 ms	22000	A
	$T_{vj} = 150$ °C; 10 ms	18000	A
$i^2t$	$T_{vj} = 25$ °C; 8,3 ... 10 ms	2420000	A <sup>2</sup> s
	$T_{vj} = 150$ °C; 8,3 ... 10 ms	1805000	A <sup>2</sup> s
$V_F$	$T_{vj} = 25$ °C; $I_F = 3000$ A	max. 1,5	V
$V_{(TO)}$	$T_{vj} = 150$ °C	max. 0,75	V
$r_T$	$T_{vj} = 150$ °C	max. 0,25	mΩ
$I_{RD}$	$T_{vj} = 150$ °C; $V_{RD} = V_{RRM}$	max. 15	mA
$R_{th(j-c)}$	cont.; per diode = per module	0,07	K/W
	sin. 180; per diode = per module	0,075	K/W
$R_{th(c-s)}$	per diode = per module	0,02	K/W
$T_{vj}$		- 40 ... + 150	°C
$T_{stg}$		- 40 ... + 130	°C
$V_{isol}$	a. c. 50 Hz; r.m.s.; 1 s / 1 min.	3600 / 3000	V~
$V_{isol}$	a. c. 50 Hz; r.m.s.; 1 s / 1 min. for SKKE...H4	4800 / 4000	V~
$M_s$	to heatsink	5 ± 15%	Nm
$M_t$	to terminals	17 ± 15 %	Nm
a		5 * 9,81	m/s <sup>2</sup>
m	approx.	940	g
Case		A 42	

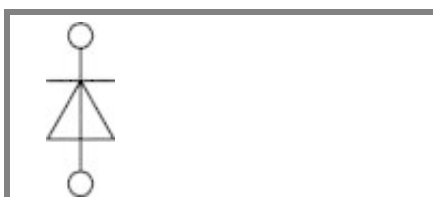

SKKE

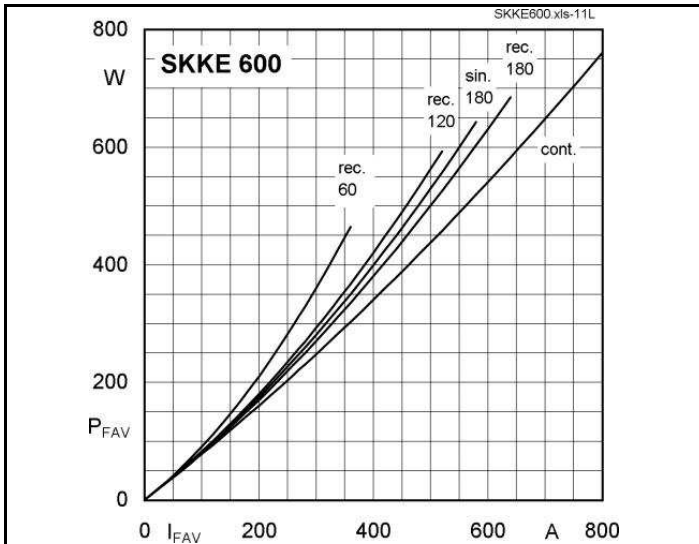

Fig. 11L Power dissipation per diode vs. forward current

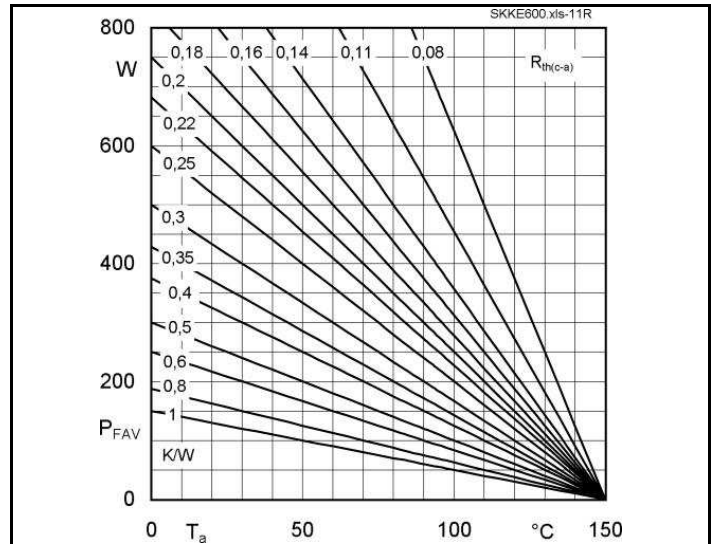

Fig. 11R Power dissipation per diode vs. ambient temperature

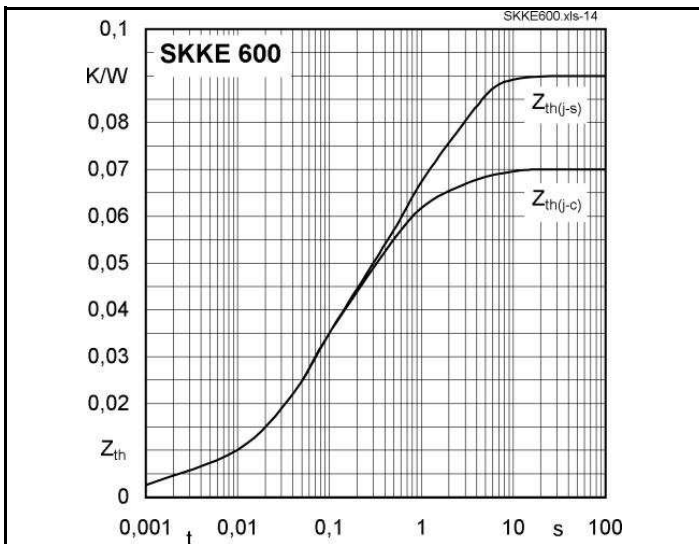

Fig. 14 Transient thermal impedance vs. time

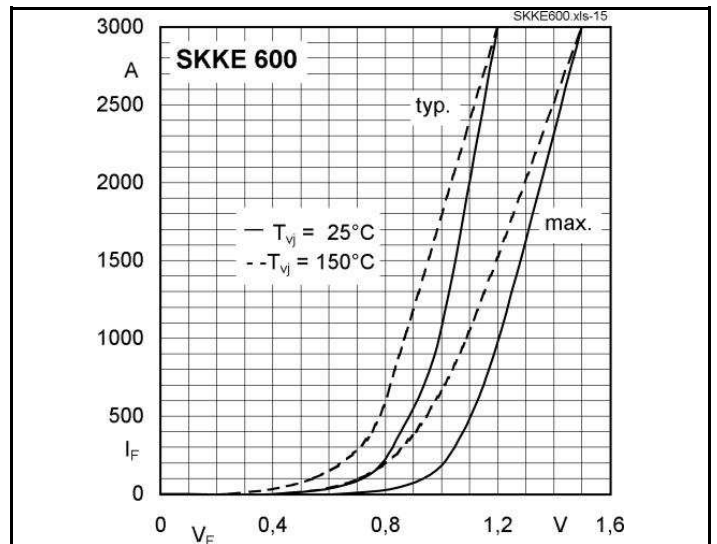

Fig. 15 Forward characteristics

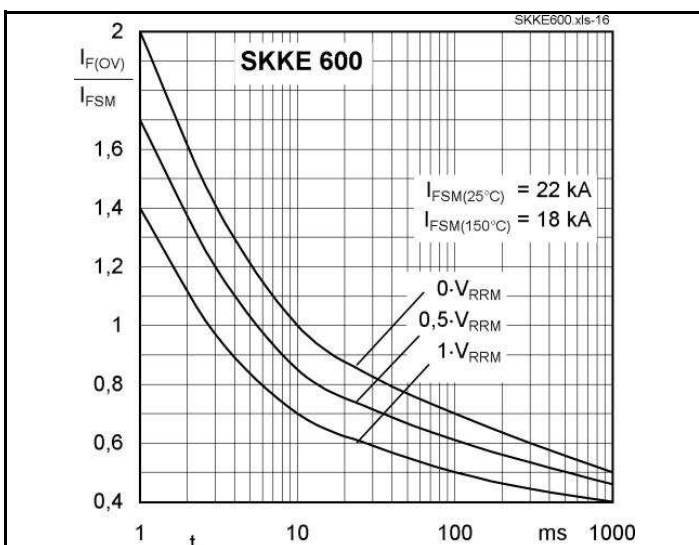
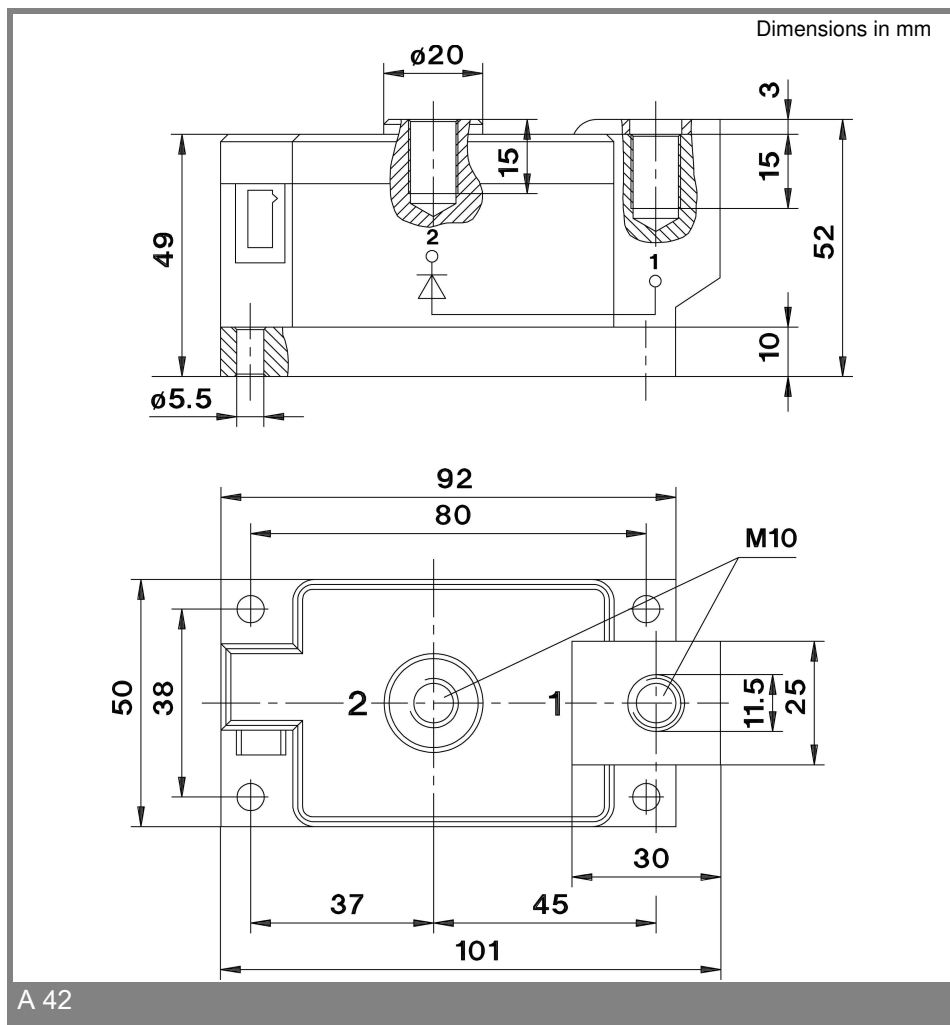

Fig. 16 Surge overload current vs. time



A 42

\* The specifications of our components may not be considered as an assurance of component characteristics. Components have to be tested for the respective application. Adjustments may be necessary. The use of SEMIKRON products in life support appliances and systems is subject to prior specification and written approval by SEMIKRON. We therefore strongly recommend prior consultation of our staff.