



SEMIPACK® 5

Thyristor Modules

SKKT 570/18 E

Features

- Heat transfer through aluminium nitride ceramic isolated metal baseplate
- Precious metal pressure contacts for high reliability
- Thyristor with amplifying gate
- UL recognized, file no. E 63 532

Typical Applications*

- AC motor softstarters
- Input converters for AC inverter drives
- DC motor control (e.g. for machine tools)
- Temperature control (e.g. for ovens, chemical, processes)
- Professionals light dimming (studios, theaters)

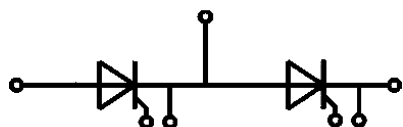

SKKT

Absolute Maximum Ratings				
Symbol	Conditions		Values	Unit
Chip				
$I_{T(AV)}$	sinus 180°	$T_c = 85\text{ °C}$	570	A
		$T_c = 100\text{ °C}$	435	A
I_{TRMS}	continuous operation		1000	A
I_{TSM}	10 ms	$T_j = 25\text{ °C}$	19000	A
		$T_j = 135\text{ °C}$	15500	A
i^2t	10 ms	$T_j = 25\text{ °C}$	1805000	A ² s
		$T_j = 135\text{ °C}$	1201250	A ² s
V_{RSM}			1900	V
V_{RRM}			1800	V
V_{DRM}			1800	V
$(di/dt)_{cr}$	$T_j = 135\text{ °C}$		250	A/μs
$(dv/dt)_{cr}$	$T_j = 135\text{ °C}$		1000	V/μs
T_j			-40 ... 135	°C
Module				
T_{stg}			-40 ... 125	°C
V_{isol}	a.c.; 50 Hz; r.m.s.	1 min	3000	V
		1 s	3600	V

Characteristics						
Symbol	Conditions		min.	typ.	max.	Unit
Chip						
V_T	$T_j = 25\text{ °C}$, $I_T = 1700\text{ A}$				1.44	V
$V_{T(TO)}$	$T_j = 135\text{ °C}$				0.78	V
r_T	$T_j = 135\text{ °C}$				0.32	mΩ
$I_{DD}; I_{RD}$	$T_j = 135\text{ °C}$, $V_{DD} = V_{DRM}$; $V_{RD} = V_{RRM}$				225	mA
t_{gd}	$T_j = 25\text{ °C}$, $I_G = 1\text{ A}$, $di_G/dt = 1\text{ A}/\mu\text{s}$			1		μs
t_{gr}	$V_D = 0.67 * V_{DRM}$			2		μs
t_q	$T_j = 135\text{ °C}$			200		μs
I_H	$T_j = 25\text{ °C}$			150	500	mA
I_L	$T_j = 25\text{ °C}$, $R_G = 33\text{ }\Omega$			300	2000	mA
V_{GT}	$T_j = 25\text{ °C}$, d.c.		3			V
I_{GT}	$T_j = 25\text{ °C}$, d.c.		200			mA
V_{GD}	$T_j = 135\text{ °C}$, d.c.				0.25	V
I_{GD}	$T_j = 135\text{ °C}$, d.c.				10	mA
$R_{th(j-c)}$	continuous DC	per chip			0.069	K/W
		per module			0.034	K/W
$R_{th(j-c)}$	sin. 180°	per chip			0.072	K/W
		per module			0.036	K/W
$R_{th(j-c)}$	rec. 120°	per chip			0.077	K/W
		per module			0.038	K/W
Module						
$R_{th(c-s)}$	chip				0.02	K/W
	module				0.01	K/W
M_s	to heatsink M6		4.25		5.75	Nm
M_t	to heatsink M10		10.2		13.8	Nm
a					5 * 9,81	m/s ²
w					1400	g

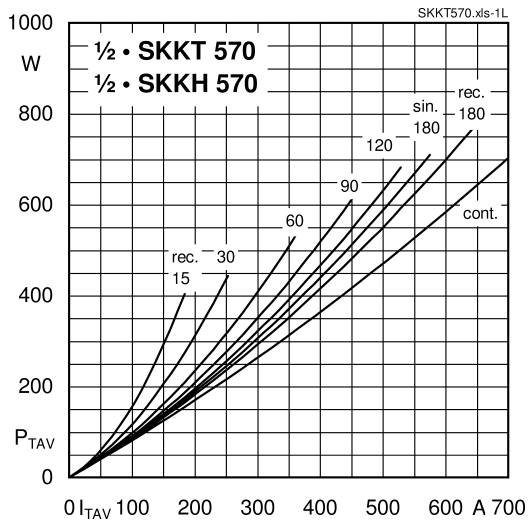

Fig. 1L: Power dissipation per thyristor vs. on-state current

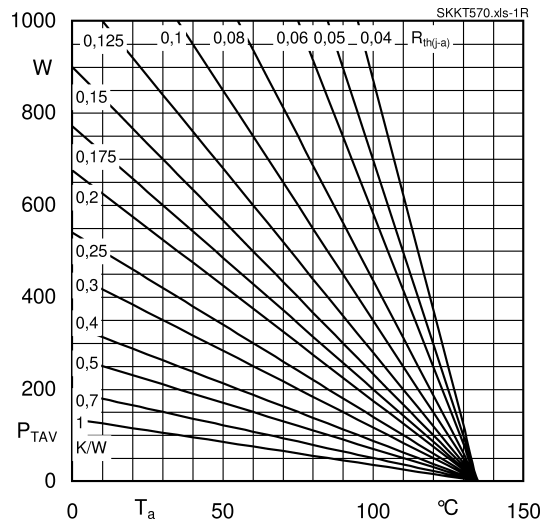

Fig. 1R: Power dissipation per thyristor vs. ambient temperature

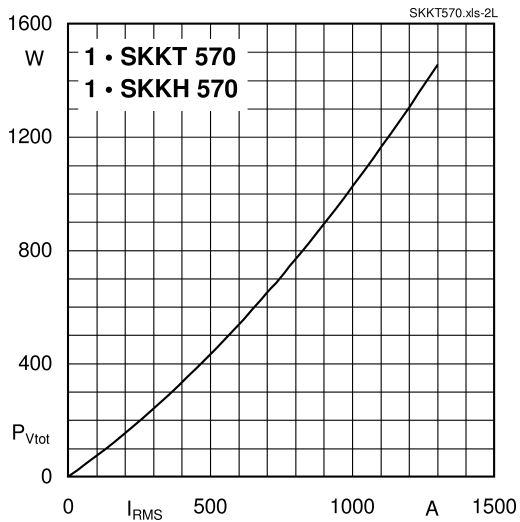

Fig. 2L: Power dissipation of one module vs. rms current

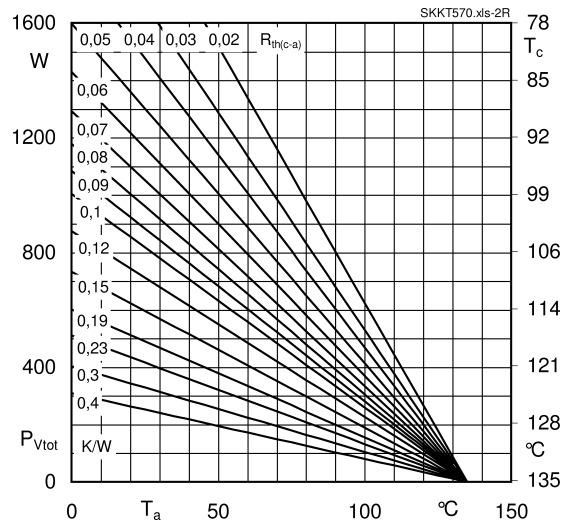

Fig. 2R: Max. power dissipation of one module vs. case temperature

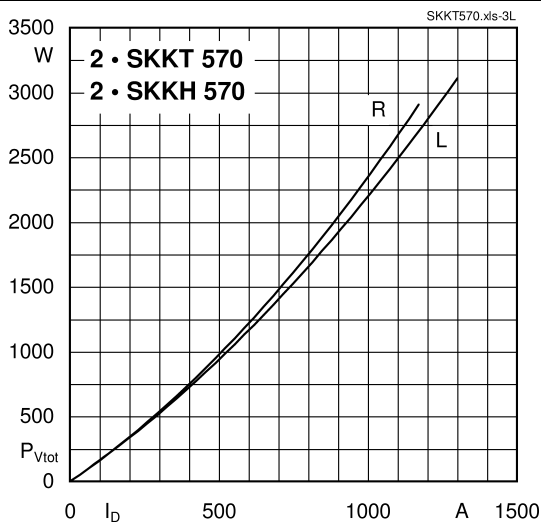

Fig. 3L: Power dissipation of two modules vs. direct current

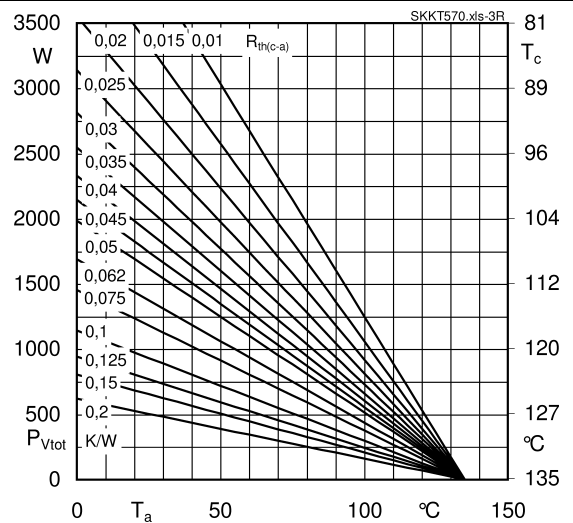

Fig. 3R: Power dissipation of two modules vs. case temperature

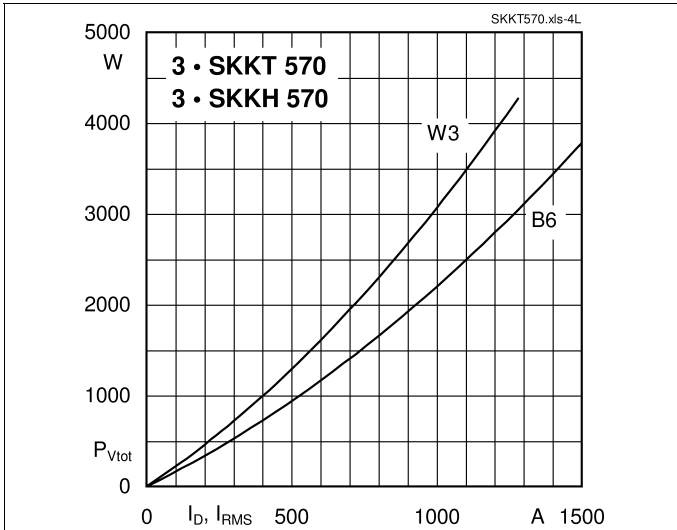

Fig. 4L: Power dissipation of three modules vs. direct and rms current

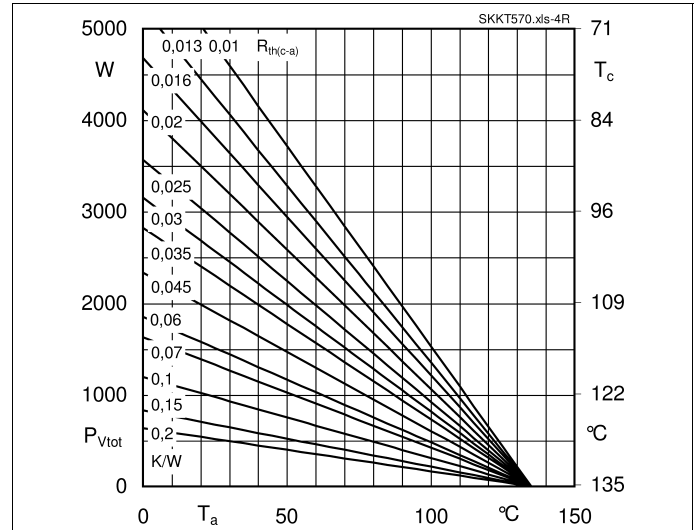

Fig. 4R: Power dissipation of three modules vs. case temperature

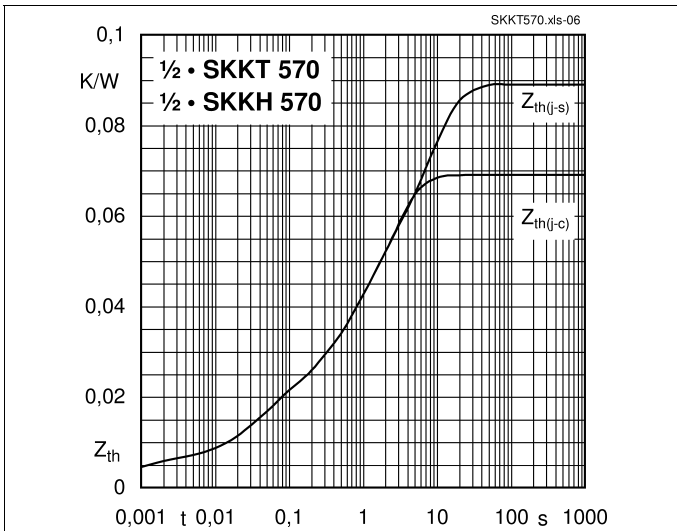

Fig. 6: Transient thermal impedance vs. time

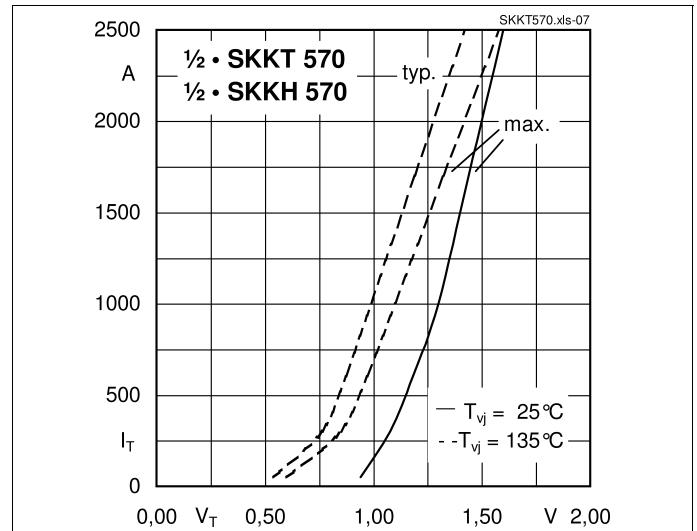

Fig. 7: On-state characteristics

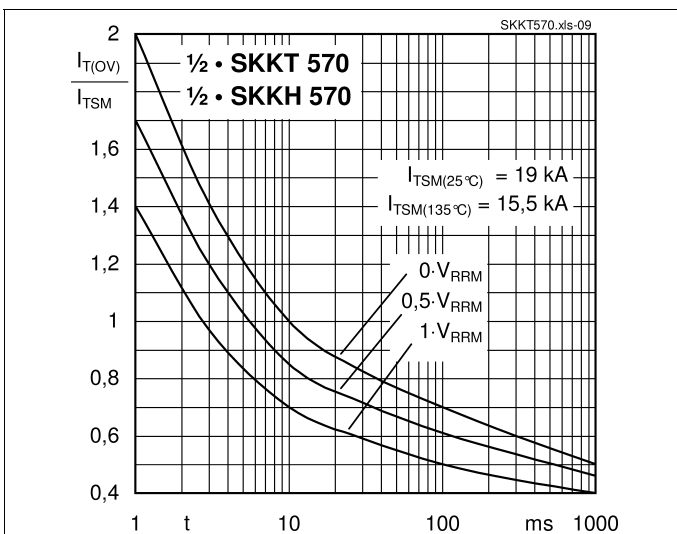

Fig. 8: Surge overload current vs. time

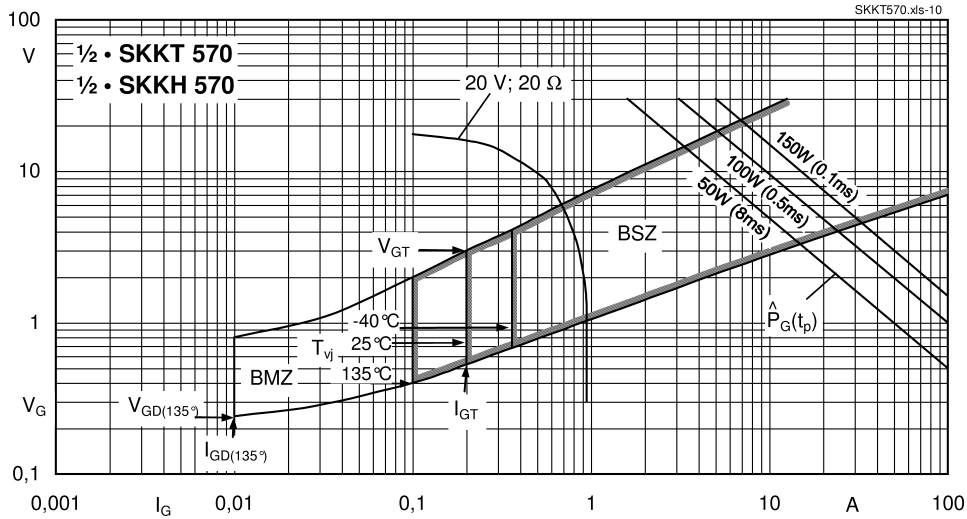
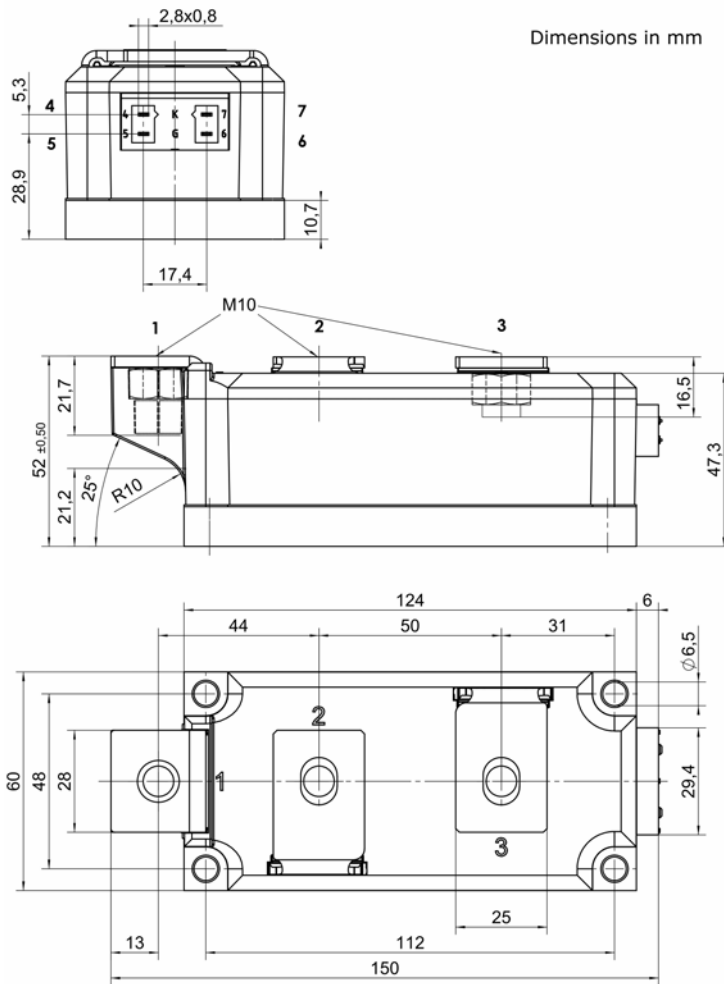
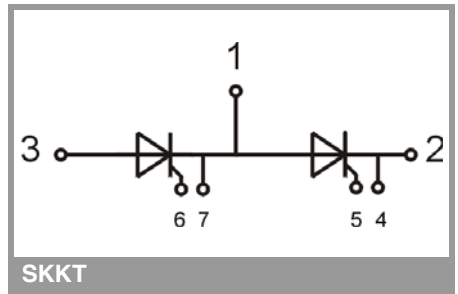

Fig. 9: Gate trigger characteristics



General tolerance ± 0.5 mm

SEMPACK 5



This is an electrostatic discharge sensitive device (ESDS), international standard IEC 60747-1, Chapter IX

* The specifications of our components may not be considered as an assurance of component characteristics. Components have to be tested for the respective application. Adjustments may be necessary. The use of SEMIKRON products in life support appliances and systems is subject to prior specification and written approval by SEMIKRON. We therefore strongly recommend prior consultation of our staff.